



Triangle



Clutch



Spanner



Hex Key



Pozidriv®



Tri-wing



Frearson



T



Torq-Set®



LOOVER INDUSTRIAL CO., LTD

1F., No.13, Ln. 219, Sec. 1, Fusing S. Rd., Taipei, Taiwan (R.O.C.)

TEL : 886-2-27732311 FAX : 886-2-27415821

URL : www.loover.com.tw

E-Mail : loover@ms15.hinet.net



1/4" = 6.35mm HEX DRIVE (DOUBLE GROOVE)

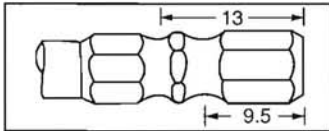

- FOR: AEROMAX, AET, ARO, ATLAS-COPCO, BIAx, B & D, BOSCH, BUCKEYE-TOOLS, CHICAGO-PNEUMATIC, CLECO, DELCO, DELVO (DENSEI), DEPRAG, DESOUTTER, FIAM, FUJI-KUKI, GARDNER-DENVER, HIOS (FERRA TOOLS), HITACHI, INGERSOLL, KELLER, MAKITA, MALL, MATSUSHITA, METABO, NPK, PNEUTEC, PREMAG, ROCKWELL, ROTOR-TOOL, SKIL, STANLEY, STAR, STAYER, THOR, TONICHI, URYU, VAN-DORN, VIRAX, WOLF, YOKOTA, YUTANI, JOHN LEE

METRIC (NON MAGNETIC)

Model No.

A/F x D x d x L

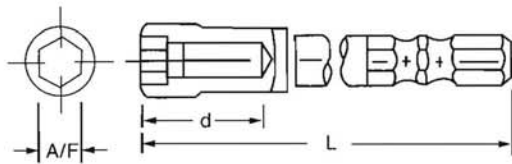

SN501555F3	5 x 8.5 x 15 x 55
SN551555F3	5.5 x 9 x 15 x 55
SN601555F3	6 x 10 x 15 x 55
SN701555F3	7 x 13 x 15 x 55
SN801555F3	8 x 13 x 15 x 55
SN901555F3	9 x 14 x 15 x 55
SN1001555F3	10 x 16 x 15 x 55
SN1101555F3	11 x 17 x 15 x 55
SN1201555F3	12 x 19 x 15 x 55
SN1301555F3	13 x 19 x 15 x 55
SN1401555F3	14 x 20 x 15 x 55
SN631165F3	1/4 x 7/16 x 2-9/16"
SN791265F3	5/16 x 1/2 x 2-9-16"
SN951465F3	3/8 x 9/16 x 2-9/16"
SN111565F3	7/16 x 5/8 x 2-9/16"
SN502565F3	5 x 8.5 x 25 x 65
SN552565F3	5.5 x 9 x 25 x 65
SN602565F3	6 x 10 x 25 x 65
SN702565F3	7 x 13 x 25 x 65
SN803065F3	8 x 13 x 30 x 65
SN903065F3	9 x 14 x 30 x 65
SN1003065F3	10 x 16 x 30 x 65
SN1103065F3	11 x 17 x 30 x 65
SN1203065F3	12 x 18 x 30 x 65
SN1303065F3	13 x 19 x 30 x 65
SN1403065F3	14 x 20 x 30 x 65
SN5025100F3	5 x 8.5 x 25 x 100
SN5525100F3	5.5 x 9 x 25 x 100
SN6025100F3	6 x 10 x 25 x 100
SN7025100F3	7 x 13 x 25 x 100
SN8030100F3	8 x 13 x 30 x 100
SN9030100F3	9 x 14 x 30 x 100
SN10030100F3	10 x 16 x 30 x 100
SN11030100F3	11 x 17 x 30 x 100
SN12030100F3	12 x 18 x 30 x 100
SN13030100F3	13 x 19 x 30 x 100
SN14030100F3	14 x 20 x 30 x 100

MAGNETIC TYPE (SN → SM) AVAILABLE ON REQUEST

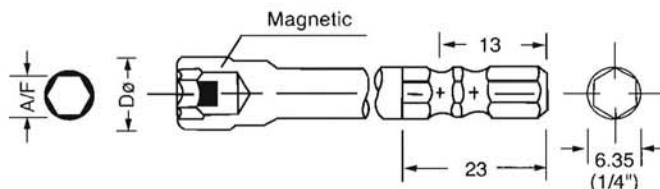

OTHER LENGTHS OR TYPES AVAILABLE ON REQUEST.

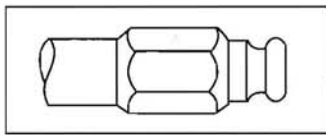

5/16" = 8mm DESOUTTER HEX DRIVE

● FOR: BRIDGES, BUCKEY-TOOLS, DEMAG(FMA), DESOUTTER, FIAM, GRASSO, OBER, RUPES, SUHNER

PHILLIPS	Model No.	P x D x L
	PH16452D8	1 x 6.4 x 52
	PH26452D8	2 x 6.4 x 52
	PH37752D8	3 x 6.4 x 52
POZIDRIV	Model No.	P x D x L
	PZ16452D8	1 x 6.4 (52mm)
	PZ26452D8	2 x 6.4 (52mm)
	PZ37752D8	3 x 7.7 (52mm)

LENGTH FOR 32mm AND 92mm AVAILABLE

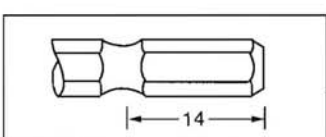

FASTENING BOLTS & NUTS 5mm HEX DRIVE

● FOR: DELVO (DENSEI), HIOS (FERRA TOOLS), HITACHI, MATSUSHITA, URYU, YOKOTA

METRIC (NON MAGNETIC)	Model No.	A/F x L
	SN5070A1	5 x 70
	SN5570A1	5.5 x 70
	SN6070A1	6 x 70
	SN7070A1	7 x 70
	SN8070A1	8 x 70
	SN9070A1	9 x 70
	SN10070A1	10 x 70
	SN11070A1	11 x 70
	SN12070A1	12 x 70
	SN13070A1	13 x 70
	SN14070A1	14 x 70

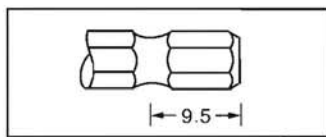

ADAPTER FOR SOCKETS 1/4" = 6.35mm HEX DRIVE

MALE SQUARE	Model No.	A/F x D x L
	AD6335B1	1/4" (or 3/8") x 1-3/8" (35mm)
	AD6351B1	1/4" (or 3/8") x 2" (51mm)
	AD6376B1	1/4" (or 3/8") x 3" (76mm)
	AD63102B1	1/4" (or 3/8") x 4" (102mm)
	AD63152B1	1/4" (or 3/8") x 6" (152mm)
	AD9535B1	3/8" x 1-3/8" (35mm)
	AD9551B1	3/8" x 2" (51mm)
	AD9576B1	3/8" x 3" (76mm)
	AD95102B1	3/8" x 4" (102mm)
	AD95152B1	3/8" x 6" (152mm)

OTHER LENGTHS OR TYPES AVAILABLE ON REQUEST.

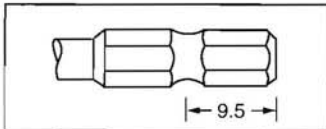

1/4" = 6.35mm HEX DRIVE

- FOR: AEROMAX, AET, ARO, ATLAS-COPCO, BIAx, B & D, BOSCH, BUCKEYE-TOOLS, CHICAGO-PNEUMATIC, CLECO, DELCO, DELVO (DENSEI), DEPRAG, DESOUTTER, FIAM, FUJI-KUKI, GARDNER-DENVER, HIOS (FERRA TOOLS), HITACHI, INGERSOLL, KELLER, MAKITA, MALL, MATSUSHITA, MET ABO, NPK, PNEUTEC, PREMAG, ROCKWELL, ROTOR-TOOL, SKIL, STANLEY, STAR, STAYER, THOR, TONICHI, URYU, VAN-DORN, VIRAX, WOLF, YOKOTA, YUTANI



T



Model No. T x D x L

TX53075B1	5 x 3.0 x 75
TX64075B1	6 x 4.0 x 75
TX74075B1	7 x 4.0 x 75
TX84575B1	8 x 4.5 x 75
TX94575B1	9 x 4.5 x 75
TX104575B1	10 x 4.5 x 75
TX154575B1	15 x 4.5 x 75
TX205075B1	20 x 5.0 x 75
TX255075B1	25 x 5.0 x 75
TX275575B1	27 x 5.5 x 75
TX306075B1	30 x 6.0 x 75
TX407075B1	40 x 7.0 x 75
TX458075B1	45 x 8.0 x 75



TRI-WING



P x L

TW03050B1	0 x 3 x 50
TW13050B1	1 x 3 x 50
TW23050B1	2 x 3 x 50
TW34050B1	3 x 4 x 50
TW44050B1	4 x 4 x 50
TW55050B1	5 x 5 x 50



TORQ-SET



P x L

TS03050B1	0 x 3 x 50
TS13050B1	1 x 3 x 50
TS23050B1	2 x 3 x 50
TS34050B1	3 x 4 x 50
TS44050B1	4 x 4 x 50
TS55050B1	5 x 5 x 50
TS65050B1	6 x 5 x 50
TS86050B1	8 x 6 x 50
TS106050B1	10 x 6 x 50



TRIANGLE



T x L

TA1850B1	TA18 x 50
TA2050B1	TA20 x 50
TA2350B1	TA23 x 50
TA2750B1	TA27 x 50



SPANNER



T x L

SP4550B1	4.5 x 50
SP5050B1	5 x 50
SP6050B1	6 x 50

OTHER LENGTHS OR TYPES AVAILABLE ON REQUEST.

1/4" = 6.35mm HEX DRIVE

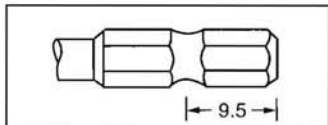

- FOR: AEROMAX, AET, ARO, ATLAS-COPCO, BIAx, B & D, BOSCH, BUCKEYE-TOOLS, CHICAGO-PNEUMATIC, CLECO, DELCO, DELVO (DENSEI), DEPRAG, DESOUTTER, FIAM, FUJI-KUKI, GARDNER-DENVER, HIOS (FERRA TOOLS), HITACHI, INGERSOLL, KELLER, MAKITA, MALL, MATSUSHITA, METABO, NPK, PNEUTEC, PREMAG, ROCKWELL, ROTOR-TOOL, SKIL, STANLEY, STAR, STAYER, THOR, TONICHI, URYU, VAN-DORN, VIRAX, WOLF, YOKOTA, YUTANI



HEXAGON HEAD (ALLEN HEAD)



Model No.

H x D x L

HX253549B1	2.5 x 3.5 x 1-15/16" (49mm)
HX303549B1	3 x 3.5 x 1-15/16" (49mm)
HX404649B1	4 x 4.6 x 1-15/16" (49mm)
HX505849B1	5 x 5.8 x 1-15/16" (49mm)
HX606049B1	6 x 1-15/16" (49mm)
HX207070B1	2 x 7 x 70
HX307070B1	3 x 7 x 70
HX407070B1	4 x 7 x 70
HX507070B1	5 x 7 x 70
HX607070B1	6 x 7 x 70
HX707070B1	7 x 10 x 70
HX807070B1	8 x 11 x 70
HX907070B1	9 x 11 x 70
HX1007070B1	10 x 12 x 70
HX2070100B1	2 x 7 x 100
HX2570100B1	2.5 x 7 x 100
HX3070100B1	3 x 7 x 100
HX4070100B1	4 x 7 x 100
HX5070100B1	5 x 7 x 100
HX6070100B1	6 x 7 x 100



SQUARE RECESS



P (Size) x L

SQ149B1	1 (3/32") x 1-15/16" (49mm)
SQ249B1	2 (1/8") x 1-15/16" (49mm)
SQ349B1	3 (9/64") x 1-15/16" (49mm)
SQ170B1	1 (3/32") x 2-3/4" (70mm)
SQ270B1	2 (1/8") x 2-3/4" (70mm)
SQ370B1	3 (9/64") x 2-3/4" (70mm)
SQ190B1	1 (3/32") x 3-1/2" (90mm)
SQ290B1	2 (1/8") x 3-1/2" (90mm)
SQ390B1	3 (9/64") x 3-1/2" (90mm)
SQ1152B1	1 (3/32") x 6" (152mm)
SQ2152B1	2 (1/8") x 6" (152mm)
SQ3152B1	3 (9/64") x 6" (152mm)

OTHER LENGTHS OR TYPES AVAILABLE ON REQUEST.

MAG-O-NETS®

Detachable Magnetic Rings
for Screwdriver Bits



Part No.	Inner Diameter (ID)	Outer Diameter (OD)	Length (mm)
AM1/4	7mm	17.5mm	10mm
AM5	6mm	15.0mm	10mm
AM3/16	3/16"	15.0mm	10mm

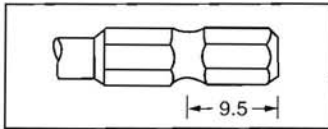

1/4" = 6.35mm HEX DRIVE

- FOR: AEROMAX, AET, ARO, ATLAS-COPCO, BIAX, B 7 D, BOSCH, BUCKEYE-TOOLS, CHICAGO-PNEUMATIC, CLECO, DELCO, DELVO (DENSEI), DEPRAG, DESOUTTER, FIAM, FUJI-KUKI, GARDNER-DENVER, HIOS (FERRA TOOLS), HITACHI, INGERSOLL, KELLER, MAKITA, MALL, MATSUSHITA, METABO, NPK, PNEUTEC, PREMAG, ROCKWELL, ROTOR-TOOL, SKIL, STANLEY, STAR, STAYER, THOR, TONICHI, URYU, VAN-DORN, VIRAX, WOLF, YOKOTA, YUTANI



POZIDRIV

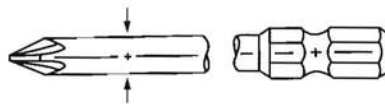

Model No.

P x D x L

PZ14749B1	1 x 3/16" x 1-15/16" (49mm)
PZ26349B1	2 x 1/4" x 1-15/16" (49mm)
PZ37949B1	3 x 5/16" x 1-15/16" (49mm)
PZ14770B1	1 x 3/16" x 2-3/4" (70mm)
PZ26370B1	2 x 1/4" x 2-3/4" (70mm)
PZ37970B1	3 x 5/16" x 2-3/4" (70mm)
PZ14789B1	1 x 3/16" x 3-1/2" (89mm)
PZ26389B1	2 x 1/4" x 3-1/2" (89mm)
PZ37989B1	3 x 5/16" x 3-1/2" (89mm)
PZ263110B1	2 x 1/4" x (110mm)
PZ263127B1	2 x 1/4" x (127mm)
PZ147152B1	1 x (3/16" x 2") x 6" (152mm)
PZ263152B1	2 x (1/4" x 2") x 6" (152mm)
PZ379152B1	3 x (5/16" x 2") x 6" (152mm)
PZ03050B1	0 x 3.0 x 50
PZ14550B1	1 x 4.5 x 50
PZ26050B1	2 x 6.0 x 50
PZ36050B1	3 x 6.0 x 50
PZ46050B1	4 x 6.0 x 50
PZ03075B1	0 x 3.0 x 75
PZ14575B1	1 x 4.5 x 75
PZ26075B1	2 x 6.0 x 75
PZ36075B1	3 x 6.0 x 75
PZ46075B1	4 x 6.0 x 75
PZ145100B1	1 x 4.5 x 100
PZ260100B1	2 x 6.0 x 100
PZ360100B1	3 x 6.0 x 100
PZ260150B1	2 x 6.0 x 150
PZ260200B1	2 x 6.0 x 200



SLOTTED

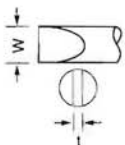

w x t x L

SL305050B1	3.0 x 0.5 x 50
SL355550B1	3.5 x 0.55 x 50
SL406050B1	4.0 x 0.6 x 50
SL457050B1	4.5 x 0.7 x 50
SL507550B1	5.0 x 0.75 x 50
SL558050B1	5.5 x 0.8 x 50
SL608550B1	6.0 x 0.85 x 50
SL658550B1	6.5 x 0.85 x 50
SL709050B1	7.0 x 0.9 x 50
SL8010050B1	8.0 x 1.0 x 50
SL9011550B1	9.0 x 1.15 x 50
SL10012050B1	10 x 1.2 x 50

OTHER LENGTHS OR TYPES AVAILABLE ON REQUEST.

1/4" = 6.35mm HEX DRIVE

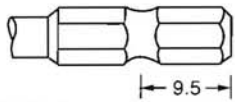

- FOR: AEROMAX, AET, ARO, ATLAS-COPCO, BIAx, B & D, BOSCH, BUCKEYE-TOOLS, CHICAGO-PNEUMATIC, CLECO, DELCO, DELVO (DENSEI), DEPRAG, DESOUTTER, FIAM, FUJI-KUKI, GARDNER-DENVER, HIOS (FERRA TOOLS), HITACHI, INGERSOLL, KELLER, MAKITA, MALL, MATSUSHITA, METABO, NPK, PNEUTEC, PREMAG, ROCKWELL, ROTOR-TOOL, SKIL, STANLEY, STAR, STAYER, THOR, TONICHI, URYU, VAN-DORN, VIRAX, WOLF, YOKOTA, YUTANI



PHILLIPS



Model No.

P x D x L

PH001549B1	00 x 1/16" x 1-15/16" (49mm)
PH03149B1	0 x 1/8" x 1-15/16" (49mm)
PH14749B1	1 x 3/16" x 1-15/16" (49mm)
PH24749B1	2 x 3/16" x 1-15/16" (49mm)
PH26349B1	2 x 1/4" x 1-15/16" (49mm)
PH37949B1	3 x 5/16" x 1-15/16" (49mm)
PH03170B1	0 x 1/8" x 2-3/4" (70mm)
PH14770B1	1 x 3/16" x 2-3/4" (70mm)
PH26370B1	2 x 1/4" x 2-3/4" (70mm)
PH37970B1	3 x 5/16" x 2-3/4" (70mm)
PH03189B1	0 x 1/8" x 3-1/2" (89mm)
PH14789B1	1 x 3/16" x 3-1/2" (89mm)
PH26389B1	2 x 1/4" x 3-1/2" (89mm)
PH37989B1	3 x 5/16" x 3-1/2" (89mm)
PH263110B1	2 x 1/4" x (110mm)
PH263127B1	2 x 1/4" x (127mm)
PH147152B1	1 x (3/16" x 2") x 6" (152mm)
PH263152B1	2 x (1/4" x 2") x 6" (152mm)
PH363152B1	3 x (1/4" x 2") x 6" (152mm)
PH001550B1	00 x 1.5 x 50H
PH03050B1	0 x 3.0 x 50H
PH14550B1	1 x 4.5 x 50H
PH24550B1	2 x 4.5 x 50H
PH26050B1	2 x 6.0 x 50H
PH03075B1	0 x 3.0 x 75G
PH14575B1	1 x 4.5 x 75H
PH24575B1	2 x 4.5 x 75H
PH26075B1	2 x 6.0 x 75H
PH36075B1	3 x 6.0 x 75H
PH145100B1	1 x 4.5 x 100H
PH245100B1	2 x 4.5 x 100H
PH260100B1	2 x 6.0 x 100H
PH360100B1	3 x 6.0 x 100H
PH145150B1	1 x 4.5 x 150H
PH245150B1	2 x 4.5 x 150H
PH260150B1	2 x 6.0 x 150H
PH260200B1	2 x 6.0 x 200H

(HEX SHANK TYPE)

P x L (Heat Treatment)



PH123B1	1 x 23H
PH223B1	2 x 23H
PH240B1	2 x 40H
PH2100B1	2 x 100H

OTHER LENGTHS OR TYPES AVAILABLE ON REQUEST.

BITS FOR PRECISION SCREWS

5mm HEX POWER BITS

DOUBLE END POWER BITS

INSERT BITS & HOLDERS

1/4" POWER BITS

POWER BITS & EXTENSIONS

SOCKET BITS (NUT SETTERS)

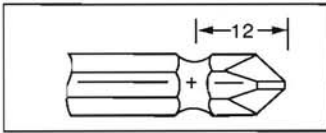

1/4" = 6.35mm HEX DRIVE

● FOR: AEROMAX, FUJI, HITACHI, MAKITA, NPK, TONICHI, URYU, YOKOTA, YUTANI



PHILLIPS

Model No.

P x L (Heat Treatment)



PH150HB2	1 x 50H
PH175HB2	1 x 75H
PH1100HB2	1 x 100H
PH1150HB2	1 x 150H
PH250HB2	2 x 50H
PH275HB2	2 x 75H
PH275GB2	2 x 75G
PH275EB2	2 x 75E
PH2100HB2	2 x 100H
PH2100GB2	2 x 100G
PH2100EB2	2 x 100E
PH2150GB2	2 x 150G
PH2200GB2	2 x 200G
PH2300HB2	2 x 300H
PH375HB2	3 x 75H
PH375EB2	3 x 75E
PH3100HB2	3 x 100H
PH3100EB2	3 x 100E



POZIDRIV



P x L



PZ145B2	1 x 45
PZ175B2	1 x 75
PZ245B2	2 x 45
PZ275B2	2 x 75



SQUARE RECESS



P (Size) x L



SQ150B2	1 (3/32") x 50
SQ175B2	1 (3/32") x 75
SQ1100B2	1 (3/32") x 100
SQ250B2	2 (1/8") x 50
SQ275B2	2 (1/8") x 75
SQ2100B2	2 (1/8") x 100
SQ2150B2	2 (1/8") x 150
SQ350B2	3 (9/64") x 50
SQ375B2	3 (9/64") x 75
SQ3100B2	3 (9/64") x 100



COMBINATION



P x w x L



PH1SL4545B2	1 x 4.5 x 45
PH1SL4575B2	1 x 4.5 x 75
PH2SL6045B2	2 x 6.0 x 45
PH2SL6075B2	2 x 6.0 x 75

OTHER LENGTHS OR TYPES AVAILABLE ON REQUEST.

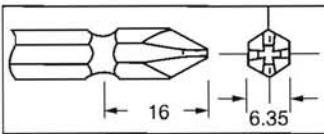

1/4" = 6.35mm HEX DRIVE

● FOR: MAKITA, MATSUSHITA, MAX, NITTO-KOKI, NPK, PYOBI, TONICHI, TOSHIBA, VESSEL, YUTANI



PHILLIPS



Model No.

P x L (Heat Treatment)

PH145HF2	1 x 45H
PH165HF2	1 x 65H
PH165GF2	1 x 65G
PH1110HF2	1 x 110H
PH1110GF2	1 x 110G
PH245HF2	2 x 45H
PH245GF2	2 x 45G
PH265HF2	2 x 65H
PH265GF2	2 x 65G
PH265EF2	2 x 65E
PH2110HF2	2 x 110H
PH2110GF2	2 x 110G
PH2110EF2	2 x 110E
PH2150HF2	2 x 150H
PH2150GF2	2 x 150G
PH2150EF2	2 x 150E
PH2200HF2	2 x 200H
PH2200GF2	2 x 200G
PH2200EF2	2 x 200E
PH2300GF2	2 x 300G
PH345HF2	3 x 45H
PH345EF2	3 x 45E
PH365HF2	3 x 65H
PH365EF2	3 x 65E
PH3110HF2	3 x 110H
PH3110EF2	3 x 110E

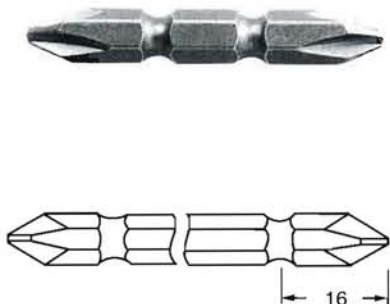

(SUPER HEAVY DUTY TYPE)

P x L

PH250SF2	2 x 50S
PH275SF2	2 x 75S
PH2100SF2	2 x 100S
PH2150SF2	2 x 150S



POZIDRIV



P x L (Heat Treatment)

PZ165F2	1 x 65H
PZ245F2	2 x 45H
PZ265F2	2 x 65H
PZ2110F2	2 x 110H
PZ365F2	3 x 65H

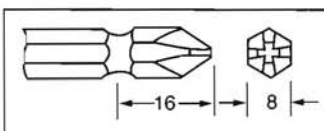

5/16" = 8mm HEX DRIVE

● FOR: HITACHI, MATSUSHITA, VESSEL



PHILLIPS



Model No.

P x L (Heat Treatment)

PH365G2	3 x 65E
PH465G2	4 x 65E



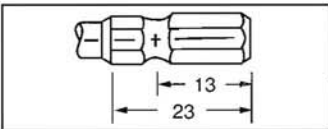

OTHER LENGTHS OR TYPES AVAILABLE ON REQUEST.



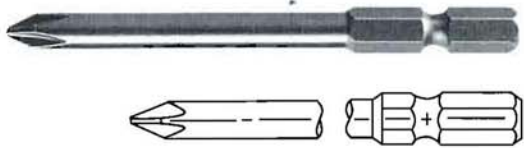

1/4" = 6.35mm HEX DRIVE

● FOR: HITACHI, MAKITA, MATSUSHITA, MAX, NPK, RYOBI, TONICHI, TOSHIBA, VESSEL, YOKOTA, YUTANI

 PHILLIPS= (M= MAGNETIC)	Model No.	P x D x L
	PH14565F1	1 x 4.5 x 65H
	PH24565F1	2 x 4.5 x 65H
	PH245100F1	2 x 4.5 x 100H
	PH245150F1	2 x 4.5 x 6.3 x 150H
	PH25082F1	2 x 5.0 x 6.0 x 82E
	PH35082F1	3 x 5.0 x 6.0 x 82E

 SLOTTED	W x T x L (Heat Treatment)	
	SL608045F1	6 x 0.8 x 45G
	SL608070F1	6 x 0.8 x 70G
	SL810045F1	8 x 1.0 x 45G
	SL810070F1	8 x 1.0 x 70G
	SL1012052F1	10 x 1.2 x 52G
	SL1012070F1	10 x 1.2 x 70G

 HEXAGON HEAD = (METRIC)	H x L (Heat Treatment)	
	HX2065F1	2 x 65H
	HX2565F1	2.5 x 65H
	HX3065F1	3 x 65H
	HX4065F1	4 x 65H
	HX5065F1	5 x 65H
	HX6065F1	6 x 65H
	HX20110F1	2 x 110H
	HX25110F1	2.5 x 110H
	HX30110F1	3 x 110H
	HX40110F1	4 x 110H
	HX50110F1	5 x 110H
	HX60110F1	6 x 110H

 T	T x D x L	
	TX104565F1	10 x 4.5 x 65
	TX154565F1	15 x 4.5 x 65
	TX204565F1	20 x 5.0 x 65
	TX254565F1	25 x 5.0 x 65
	TX274565F1	27 x 5.5 x 65
	TX304565F1	30 x 6.0 x 65
	TX404565F1	40 x 7.0 x 65

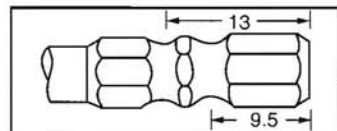

1/4" = 6.35mm HEX DRIVE (DOUBLE GROOVE, MAGNETIC TYPE)

● FOR: VARIOUS TYPES OF POWER TOOLS

 PHILLIPS	Model No.	P x D1 x D2 x L
	PH24565F3	2 x 4.5 x 65H
	PH245100F3	2 x 4.5 x 100H
	PH245150F3	2 x 4.5 x 6.3 x 150H

OTHER LENGTHS OR TYPES AVAILABLE ON REQUEST.

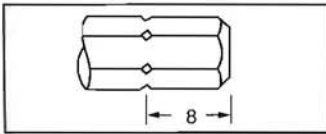

1/4" = 6.35mm HEX SHANK

● FOR: 1/4" HEX OPENING BIT HOLDERS



TORO-SET



Model No.

P x L

TS125I6	1 x 1"
TS225I6	2 x 1"
TS325I6	3 x 1"
TS425I6	4 x 1"



T (H = Tamper Proof)



T x L

TX625I6	6 x 25
TX725I6	7 x 25
TX825I6	8 x 25
TX925I6	9 x 25
TX1025I6	10 x 25
TX1525I6	15 x 25
TX2025I6	20 x 25
TX2525I6	25 x 25
TX2725I6	27 x 25
TX3025I6	30 x 25
TX4025I6	40 x 25
TX8H25I6	8H x 25
TX9H25I6	9H x 25
TX10H25I6	10H x 25
TX15H25I6	15H x 25
TX20H25I6	20H x 25
TX25H25I6	25H x 25
TX27H25I6	27H x 25
TX30H25I6	30H x 25
TX40H25I6	40H x 25

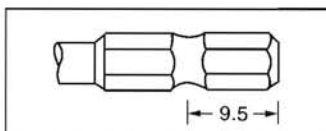
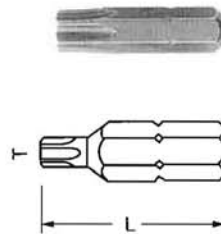
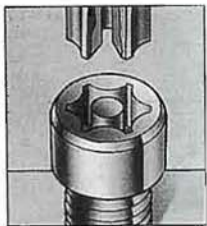

1/4" = 6.35mm HEX BIT HOLDER

● FOR: AEROMAX, AET, ARO, ATLAS-COPCO, BIAx, B & D, BOSCH, BUCKEYE-TOOLS, CHICAGO-PNEUMATIC, CLECO, DELCO, DELVO (DENSEI), DEPRAG, DESOUTTER, FIAM, FUJI-KUKI, GARDNER-DENVER, HIOS (FERRA TOOLS), HITACHI, INGERSOLL, KELLER, MAKITA, MALL, MATSUSHITA, METABO, NPK, PNEUTEC, PREMAG, ROCKWELL, ROTOR-TOOL, SKIL, STANLEY, STAR, STAYER, THOR, TONICHI, URYU, VAN-DORN, VIRAX, WOLF, YOKOTA, YUTANI

FOR 1/4" HEX INSERT BITS

Model No.

O. A. L.



BH654BI	2-1/8" (54mm)
BH6102BI	4" (102mm)
BH6152BI	6" (152mm)
BH6203BI	8" (203mm)
BH6254BI	10" (254mm)
BH6305BI	12" (305mm)
BH650D8	50mm
BH676D8	76mm

OTHER LENGTHS OR TYPES AVAILABLE ON REQUEST.

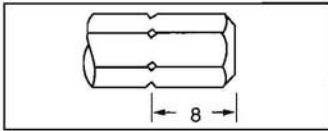

1/4" = 6.35mm HEX SHANK

● FOR: 1/4" HEX OPENING BIT HOLDERS



PHILLIPS

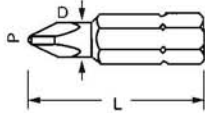

Model No.

P x D x L

PH025416	0 x 3.0 x 1" (25.4mm)
PH125416	1 x 4.5 x 1" (25.4mm)
PH225416	2 x 6.0 x 1" (25.4mm)
PH325416	3 x 6.0 x 1" (25.4mm)
PH238116	2 x 1-1/2" (38.1mm)
PH14916	1 x 1-5/16" (49mm)
PH24916	2 x 1-5/16" (49mm)
PH34916	3 x 1-5/16" (49mm)
PH263516	2 x 2-1/2" (63.5mm)



POZIDRIV

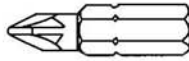

P x L

PZ125416	1 x 1" (25.4mm)
PZ225416	2 x 1" (25.4mm)
PZ325416	3 x 1" (25.4mm)
PZ14916	1 x 1-5/16" (49mm)
PZ24916	2 x 1-5/16" (49mm)
PZ34916	3 x 1-5/16" (49mm)



SLOTTED

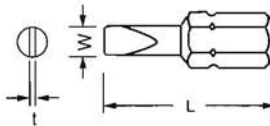

w x t x L

SL30502516	3.0 x 0.5 x 25
SL35552516	3.5 x 0.55 x 25
SL40602516	4.0 x 0.6 x 25
SL45702516	4.5 x 0.7 x 25
SL50752516	5.0 x 0.75 x 25
SL55802516	5.5 x 0.8 x 25
SL60852516	6.0 x 0.85 x 25
SL65852516	6.5 x 0.85 x 25
SL70902516	7.0 x 0.9 x 25
SL75952516	7.5 x 0.95 x 25
SL801002516	8.0 x 1.0 x 25



HEXAGON

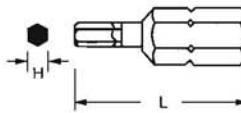

H x L

HX3125416	1/8" x 1" (25.4mm)
HX3525416	9/64" x 1" (25.4mm)
HX394916	5/32" x 1-5/16" (49mm)
HX474916	3/16" x 1-5/16" (49mm)
HX554916	7/32" x 1-5/16" (49mm)
HX634916	1/4" x 1-5/16" (49mm)
HX202516	2.0 x 25
HX252516	2.5 x 25
HX302516	3.0 x 25



SQUARE RECESS

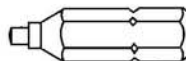

P (Size) x L

SQ025416	0 (1/16") x 1"
SQ125416	1 (3/32") x 1"
SQ225416	2 (1/8") x 1"
SQ325416	3 (9/64") x 1"

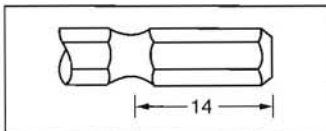

5mm HEX DRIVE

● FOR: AEROMAX, DENSEI, HIOS, HITACHI, MATSUSHITA, URYU, YOKOTA



PHILLIPS

Model No.

P x d x ℓ x L



PH02570A1	0 x 2.5 x 30 x 70
PH13070A1	1 x 3.0 x 30 x 70
PH14070A1	1 x 4.0 x 30 x 70
PH140110A1	1 x 4.0 x 30 x 110
PH16050A1	1 x 6.0 x 50
PH160100A1	1 x 6.0 x 100
PH160125A1	1 x 6.0 x 125
PH23070A1	2 x 3.0 x 30 x 70
PH25070A1	2 x 5.0 x 30 x 70
PH250110A1	2 x 5.0 x 30 x 110
PH26050A1	2 x 6.0 x 50
PH260100A1	2 x 6.0 x 100
PH260125A1	2 x 6.0 x 125
PH260150A1	2 x 6.0 x 150
PH260200A1	2 x 6.0 x 200
PH36070A1	3 x 6.0 x 70



T (H = Tamper Proof)

T x d x ℓ x L



TX67075A1	6 x 2.0 x 30 x 75
TX72075A1	7 x 2.0 x 30 x 75
TX82575A1	8 x 2.5 x 30 x 75
TX92575A1	9 x 2.5 x 30 x 75
TX103075A1	10 x 3.0 x 30 x 75
TX153575A1	15 x 3.5 x 30 x 75
TX205075A1	20 x 5.0 x 30 x 75
TX255075A1	25 x 5.0 x 30 x 75
TX275075A1	27 x 5.0 x 30 x 75



HEXAGON HEAD

H x D x L



HX2070A1	2 x 6 x 70
HX2570A1	2.5 x 6 x 70
HX3070A1	3 x 6 x 70
HX4070A1	4 x 6 x 70
HX5070A1	5 x 6 x 70

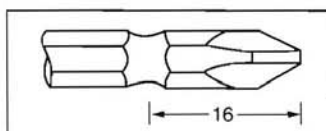

5mm DOUBLE END HEX DRIVE

● FOR: DENSEI, HITACHI, HIOS, MATSUSHITA, URYU, YOKOTA



PHILLIPS



P x L (Heat Treatment)



PH170A2	1 x 70H
PH1100A2	1 x 100H
PH270A2	2 x 70H
PH2100A2	2 x 100H
PH2150A2	2 x 150H
PH2200A2	2 x 200H
PH2250A2	2 x 250H
PH2300A2	2 x 300H

OTHER LENGTHS OR TYPES AVAILABLE ON REQUEST.

PRODUCTION INLINE TOOLS

Ø4mm DRIVE

● FOR: DENSEI

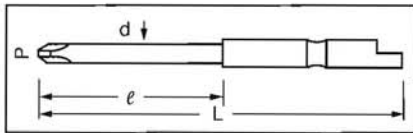

PHILLIPS

Model No.

P x d x ℓ x L



PH002044D4	00 x 2.0 x 20 x 44
PH02544D4	0 x 2.5 x 20 x 44
PH13044D4	1 x 3.0 x 20 x 44
PH14044D4	1 x 4.0 x 20 x 44
PH24044D4	2 x 4.0 x 20 x 44



SLOTTED

w x t x ℓ x L



SL304044D4	3 x 0.4 x 20 x 44
SL405044D4	4 x 0.5 x 20 x 44



HEXAGON HEAD

H x L



HX1544D4	1.5 x 44
HX2044D4	2.0 x 44
HX2544D4	2.5 x 44
HX3044D4	3.0 x 44



T (H = Tamper Proof)

T x L



TX544D4	5.0 x 44
TX644D4	6.0 x 44
TX8H44D4	8H x 44
TH10H44D4	10H x 44
TX15H44D4	15H x 44

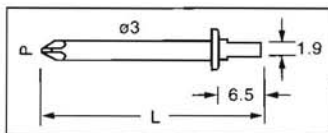

Ø3mm DRIVE

● FOR: VESSEL



PHILLIPS

P x L (Heat Treatment)



PH036C3	0 x 36H
PH136C3	1 x 36H
PH170C3	1 x 70H
PH1100C3	1 x 100H

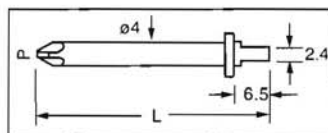

Ø4mm DRIVE

● FOR: VESSEL



PHILLIPS

P x L (Heat Treatment)



PH036C4	0 x 36H
PH136C4	1 x 36H
PH170C4	1 x 70H
PH1100C4	1 x 100H

OTHER LENGTHS OR TYPES AVAILABLE ON REQUEST.

PRODUCTION INLINE TOOLS
Ø5mm SHANK DRIVE

● FOR: AEROMAX, DENSI, HIOS

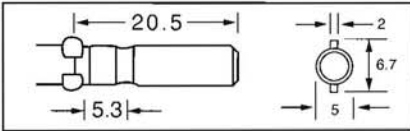

BITS FOR PRECISION SCREWS

5mm HEX POWER BITS

DOUBLE END POWER BITS

INSERT BITS & HOLDERS

1/4" POWER BITS

POWER BITS & EXTENSIONS

SOCKET BITS (NUT SETTERS)



PHILLIPS

Model No.

P x d x ℓ x L



PH002060E5	00 x 2.0 x 20 x 60
PH02560E5	0 x 2.5 x 25 x 60
PH12660E5	1 x 2.6 x 25 x 60
PH12680E5	1 x 2.6 x 25 x 80
PH126100E5	1 x 2.6 x 25 x 100
PH13060E5	1 x 3.0 x 25 x 60
PH13080E5	1 x 3.0 x 25 x 80
PH130100E5	1 x 3.0 x 25 x 100
PH15060E5	1 x 5.0 x 60
PH15080E5	1 x 5.0 x 80
PH150100E5	1 x 5.0 x 100
PH150120E5	1 x 5.0 x 120
PH150150E5	1 x 5.0 x 150
PH25060E5	2 x 5.0 x 60
PH25080E5	2 x 5.0 x 80
PH250100E5	2 x 5.0 x 100
PH250120E5	2 x 5.0 x 120
PH250150E5	2 x 5.0 x 150



T (H = Tamper Proof)

T x d x ℓ x L



TX55060E5	5 x 5 x 60
TX65060E5	6 x 5 x 60
TX75060E5	7 x 5 x 60
TX8H5060E5	8H x 5 x 60
TX9H5060E5	9H x 5 x 60
TX10H5060E5	10H x 5 x 60
TX15H5060E5	15H x 5 x 60



SLOTTED

w x t x ℓ x L



SL203060E5	2 x 0.3 x 25 x 60
SL254060E5	2.5 x 0.4 x 25 x 60
SL304060E5	3 x 0.4 x 25 x 60
SL406060E5	4 x 0.6 x 25 x 60
SL507560E5	5 x 0.75 x 60



TRIANGLE

T x L



TA1860E5	TA18 x 60
TA2060E5	TA20 x 60
TA2360E5	TA23 x 60
TA2760E5	TA27 x 60



TRI-WING

P x L



TW060E5	0 x 60
TW160E5	1 x 60
TW260E5	2 x 60
TW360E5	3 x 60
TW460E5	4 x 60
TW560E5	5 x 60



SPANNER

P x L



SP4560E5	4.5 x 60
SP5060E5	5 x 60
SP6060E5	6 x 60

OTHER LENGTHS OR TYPES AVAILABLE ON REQUEST.

PRODUCTION INLINE TOOLS
Ø4mm SHANK DRIVE

● FOR: AEROMAX, DENSI, HIOS

SOCKET BITS (NUT SETTERS) POWER BITS & EXTENSIONS 1/4" POWER BITS INSERT BITS & HOLDERS DOUBLE END POWER BITS 5mm HEX POWER BITS BITS FOR PRECISION SCREWS

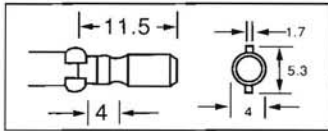

PHILLIPS

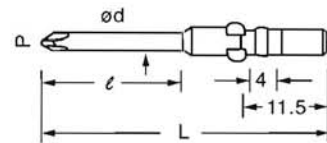

Model No.

P x d x ℓ x L

PH001240E4	00 x 1.2 x 20 x 40
PH001260E4	00 x 1.2 x 20 x 60
PH001540E4	00 x 1.5 x 20 x 40
PH001560E4	00 x 1.5 x 20 x 60
PH001740E4	00 x 1.7 x 20 x 40
PH001760E4	00 x 1.7 x 20 x 60
PH002040E4	00 x 2.0 x 20 x 40
PH002060E4	00 x 2.0 x 20 x 60
PH02540E4	0 x 2.5 x 20 x 40
PH02560E4	0 x 2.5 x 20 x 60
PH02580E4	0 x 2.5 x 20 x 80
PH025100E4	0 x 2.5 x 20 x 100
PH0253100E4	0 x 2.5 x 30 x 100
PH12540E4	1 x 2.5 x 20 x 40
PH13040E4	1 x 3.0 x 20 x 40
PH13060E4	1 x 3.0 x 20 x 60
PH13080E4	1 x 3.0 x 20 x 80
PH130100E4	1 x 3.0 x 20 x 100
PH14040E4	1 x 4.0 x 40
PH14060E4	1 x 4.0 x 60
PH14080E4	1 x 4.0 x 80
PH140100E4	1 x 4.0 x 100
PH23040E4	2 x 3.0 x 20 x 40
PH24040E4	2 x 4.0 x 40
PH24060E4	2 x 4.0 x 60
PH24080E4	2 x 4.0 x 80
PH240100E4	2 x 4.0 x 100
PH240120E4	2 x 4.0 x 120



SLOTTED

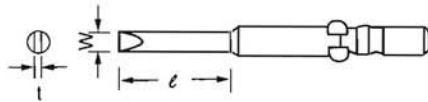

w x t x ℓ x L

SL112840E4	1.1 x 0.28 x 20 x 40
SL153040E4	1.5 x 0.30 x 20 x 40
SL173040E4	1.7 x 0.30 x 20 x 40
SL184040E4	1.8 x 0.40 x 20 x 40
SL204040E4	2.0 x 0.40 x 20 x 40
SL254040E4	2.5 x 0.40 x 20 x 40
SL304040E4	3.0 x 0.40 x 20 x 40
SL406040E4	4.0 x 0.60 x 20 x 40



T (H = Tamper Proof)



T x d x ℓ x L

TX52040E4	5 x 2.0 x 20 x 40
TX52060E4	5 x 2.0 x 20 x 60
TX62040E4	6 x 2.0 x 20 x 40
TX62060E4	6 x 2.0 x 20 x 60
TX64060E4	6 x 4.0 x 60
TX72060E4	7 x 2.0 x 20 x 60
TX74060E4	7 x 4.0 x 60
TX8H4060E4	8H x 4.0 x 60
TX9H4060E4	9H x 4.0 x 60
TX10H4060E4	10H x 4.0 x 60
TX15H4060E4	15H x 4.0 x 60

OTHER LENGTHS OR TYPES AVAILABLE ON REQUEST.

